



Long-lasting and low maintenance, LED-based light sources are an excellent solution for all lighting applications. For optimal performance, these solutions require reliable drivers matching the long lifetime of the LEDs. The Philips Advance Xitanium LED Outdoor Driver portfolio offers a range of products specially designed to operate LED solutions in outdoor applications. These drivers are designed for hard-wired integration into outdoor luminaires for the most rugged applications. They operate to specification under wide temperature and electrical ranges to ensure reliability.

Specifications

Input Volt. (Vac)	Output Power (W)	Output Voltage (V)	Output Current (A)	Efficiency @ Max Load and 75°C Case (%)	Max Case Temp. (°C)	Input Current (A)	Max. Input Power (W)	THD @ Max Load (%)	Power Factor @ Max Load	Surge Protection (Ring Wave, KV)	Envir. Protection Rating	Dimming	Dimming Range (with specified dimmers)	Min. Output Current (A)	Driver Type
120	50	20 - 48 Class 2 Output	0.1 - 1.4	86	Life-75°C UL-85°C	0.5	61	<15%	>0.90	2.5	UL damp & dry	0-10V Analog Class 2 Wiring Only	1% - 100% (Constant Current)	0.008	Constant Current
277				87		0.22		<15%							

Enclosure

	In. (mm)	Tolerance
Overall Length (A1)	11.02(280)	± 0.5mm
Mounting Length (A2)	10.63(270)	± 0.5mm
Case Length (A3)	8.81(223.8)	± 0.5mm
Case Width (B1)	1.18(29.4)	± 0.5mm
Case Height (C1)	1.0(25.4)	± 1.0mm
Mounting Hole Diameter (D1)	0.31(8.0)	± 0.3mm
Center of SimpleSet Antenna (G1)	0.76(19.2)	± 3.0mm

Mechanical Diagram

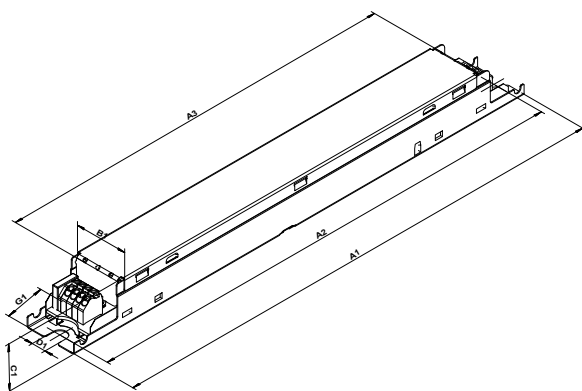

Wiring Diagram

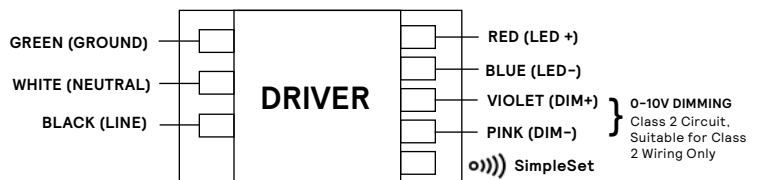

Warning

- Install in accordance with national and local electrical codes.
- The field-wiring leads or push-in terminals shall be fully enclosed.
- Use 18 AWG Solid Copper Wire Rated $\geq 90^\circ\text{C}$.
- Strip Wire 3/8".
- For Class 2 Wiring, Use 20 AWG-16 AWG.

Grounding

- Driver case must be grounded.



Xitanium XI050C140V048BPT1

50W 0.1-1.4A 48V 0-10V INT (1% dim) with SimpleSet

Features

- High efficiency (>86%)
- 1% min. dim level, 0-10V Dimming
- UL Class P

Benefits

- Allows basic programmability for setting discrete output current levels
- Design flexibility to meet DLC requirements
- Low dimming to cover all major linear applications
- Standard mechanical fit with 280mm mounting distance

Application

- Indoor Linear troffers, pendants
- Office areas
- Retail Centers
- Educational facilities

Electrical Specifications

All the specifications are typical and at 25°C Tcase unless specified otherwise.

Product Data

Order Information	
Full Product Code	XI050C140V048BPT1 (Mid-Pack, 18pcs/Box), 12NC: 929002735413
Line Frequency	50/60Hz
Min. Mains Voltage Operational	108 Vac
Max. Mains Voltage Operational	305 Vac
Output Information	
Maximum Open Circuit Voltage	60Vdc
Output Current Ripple	15% max @ max Iout
Output Current Tolerance (in the performance window)	<5%
Protections	Short Circuit, Open Circuit Protection for LED + and LED -
Features	
0-10V Dimming Interface Current	100-250µA
0-10V Active Range	1V to 8V. See dim curve for details
AOC (Adjustable Output Current)	0.1A-1.4A via SimpleSet (Factory Default at 1.4A)
Additional SimpleSet Configurable Features	Adjustable Minimum dim level Adjustable Output Current (AOC) OEM Write Protected features (OWP)
Environment & Approbation	
Operating Ambient Temp. Range	-40°C to +50°C
Driver Lifetime up to Tc Life	50k Hours
Thermal fold-back at High Temperature	Not supported
Agency Approbations	UL8750, NOM, Class P(cUL, UL)
Electromagnetic Compliance	FCC Title 47 Part 15 Class A
Audible Noise	<24dB Class A
Weight	0.498Lbs/0.226Kgs

Xitanium XI050C140V048BPT1

50W 0.1-1.4A 48V 0-10V INT (1% dim) with SimpleSet

Electrical Specifications

All the specifications are typical and at 25°C Tcase unless specified otherwise.

0-10V Dimming Interface

Dimming source current from the driver: 100-250µA (@ 0<Vdim<8V)

Maximum output voltage on the dimming wires: 12V

Leakage current of dimming leads: 0.018mA, recommendation of max number of control circuits in parallel can be found in Design-In Guide.

Approved Dimmer List

Manufacturer	Manufacturer Part Number
Lutron	Visit www.lutron.com/advance for a list of dimmers (Mark VII) that will work with this driver
Leviton	IllumaTech IP7 series
Advance	Sunrise - SR1200ZTUNV

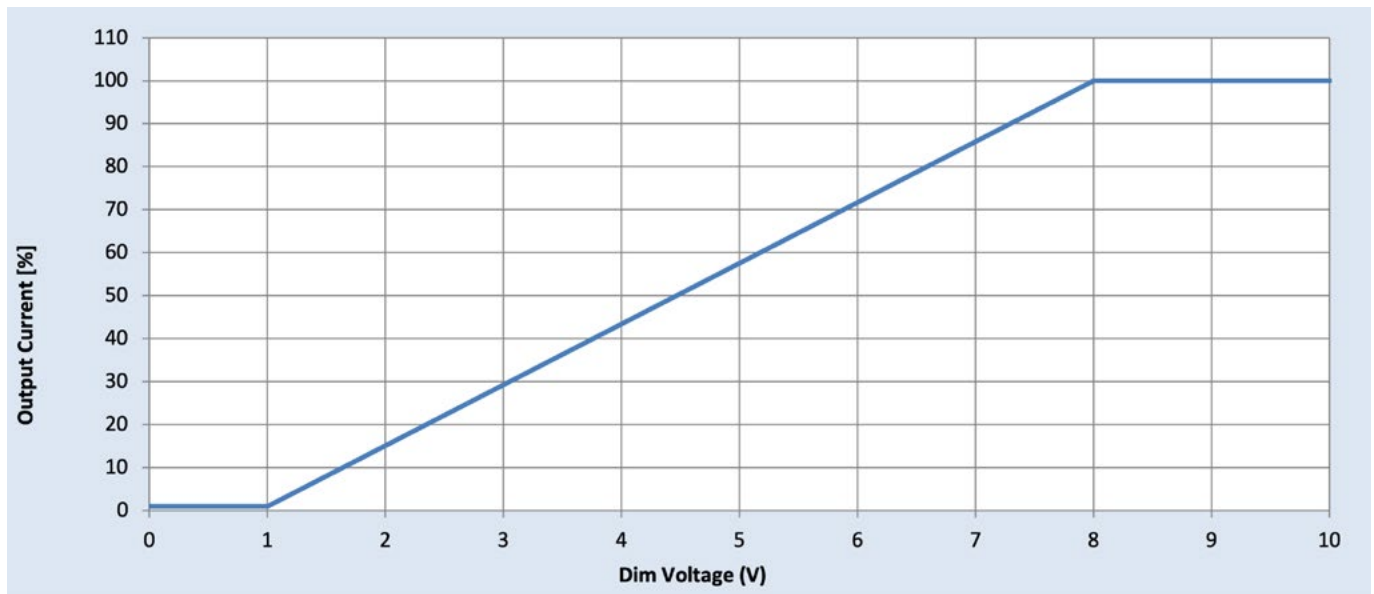

Xitanium XI050C140V048BPT1

50W 0.1-1.4A 48V 0-10V INT (1% dim) with SimpleSet

Electrical Specifications

All the specifications are typical and at 25°C Tcase unless specified otherwise.

Driver Operation Window:

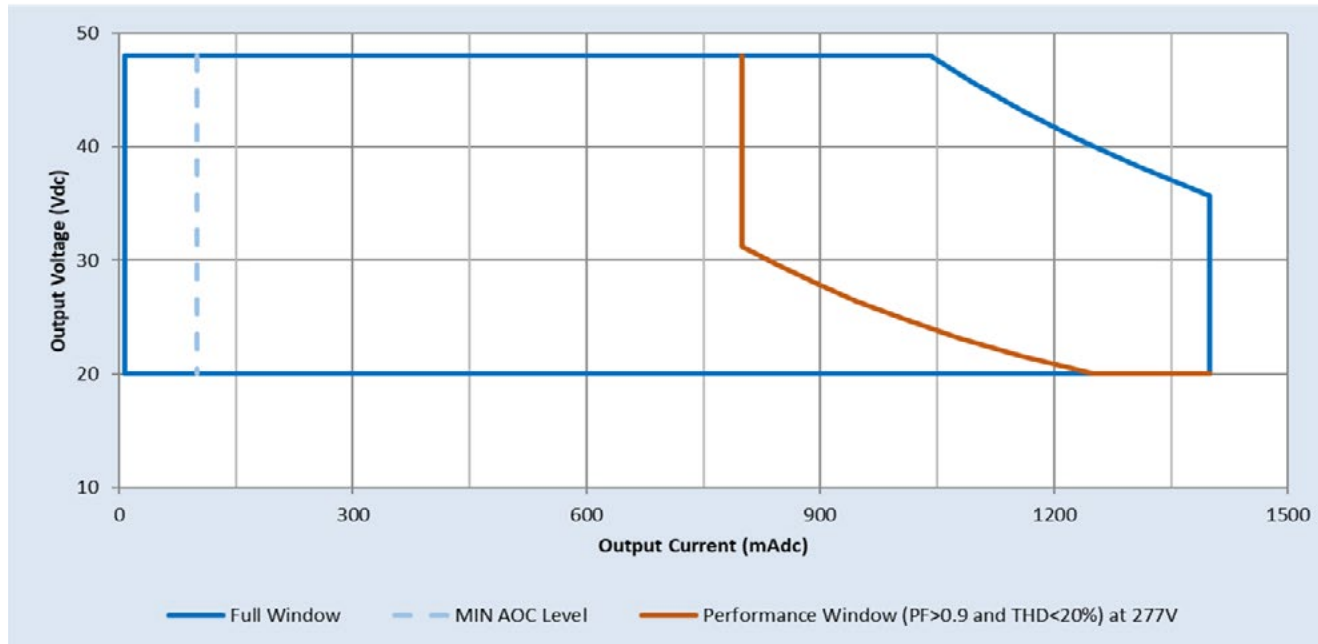

Notes

1. Factory default output current is 1.4A.
2. To get a 100% to 1% dimming range, the output current setting through AOC should be $\geq 0.8A$.
3. Factory default minimum dimming level is 1%. This can be adjusted between 1% and 100% using MultiOne.

Xitanium XI050C140V048BPT1

50W 0.1-1.4A 48V 0-10V INT (1% dim) with SimpleSet

Electrical Specifications

All the specifications are typical and at 25°C Ta unless specified otherwise

Output Current Vs. Driver Case Temperature

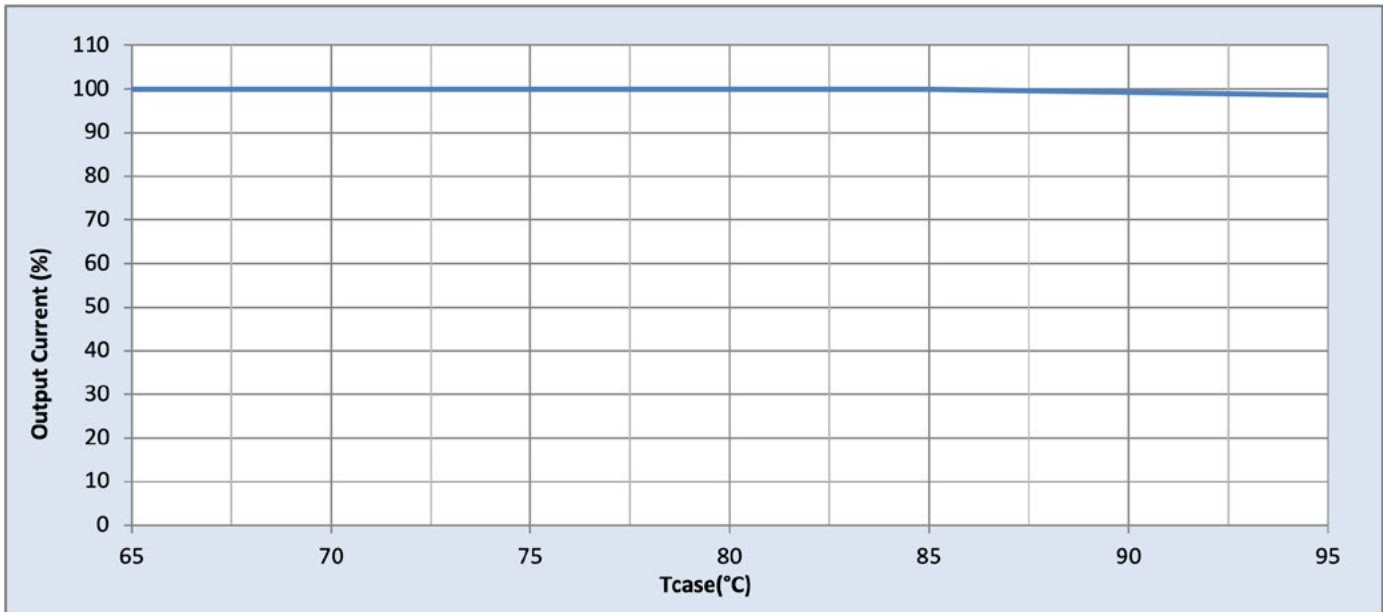

Note: There is ±5°C tolerance on the driver case temperature

Driver Lifetime vs. Driver Case Temperature

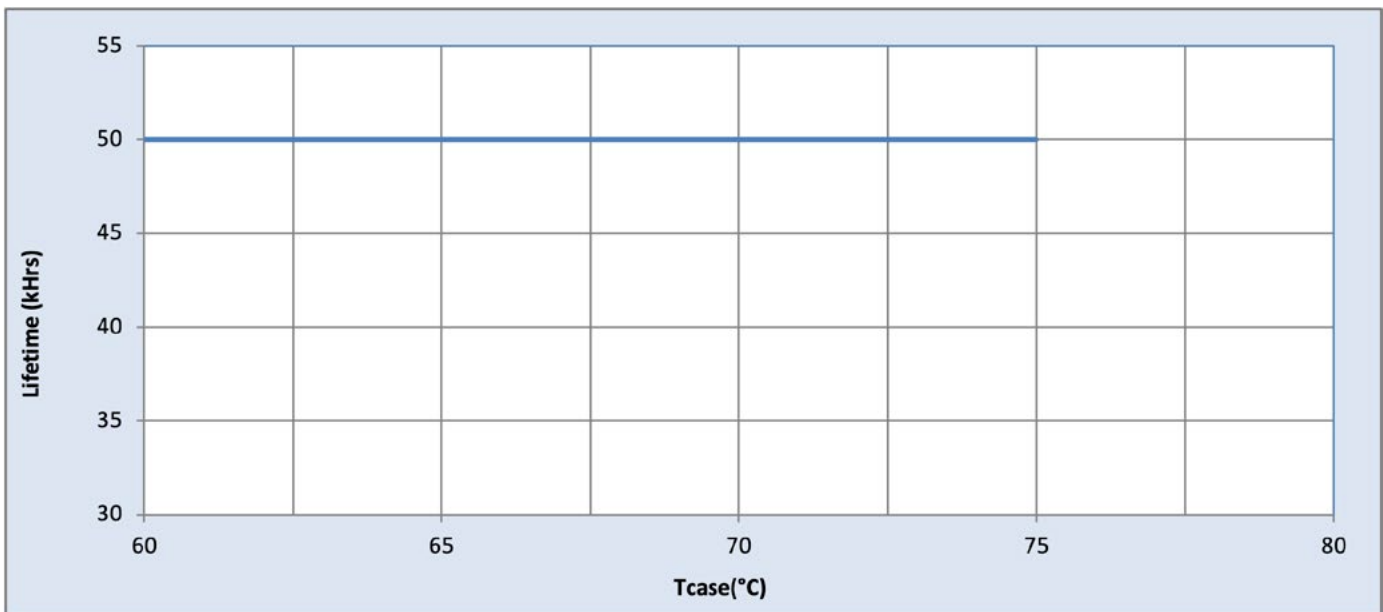

Xitanium XI050C140V048BPT1

50W 0.1-1.4A 48V 0-10V INT (1% dim) with SimpleSet

Performance Characteristics

Based on measurements on a typical sample at 70°C case. The accuracy of the measurements is within the tolerance of the measurement instruments.

Efficiency Vs. Output Voltage at 120Vac Input

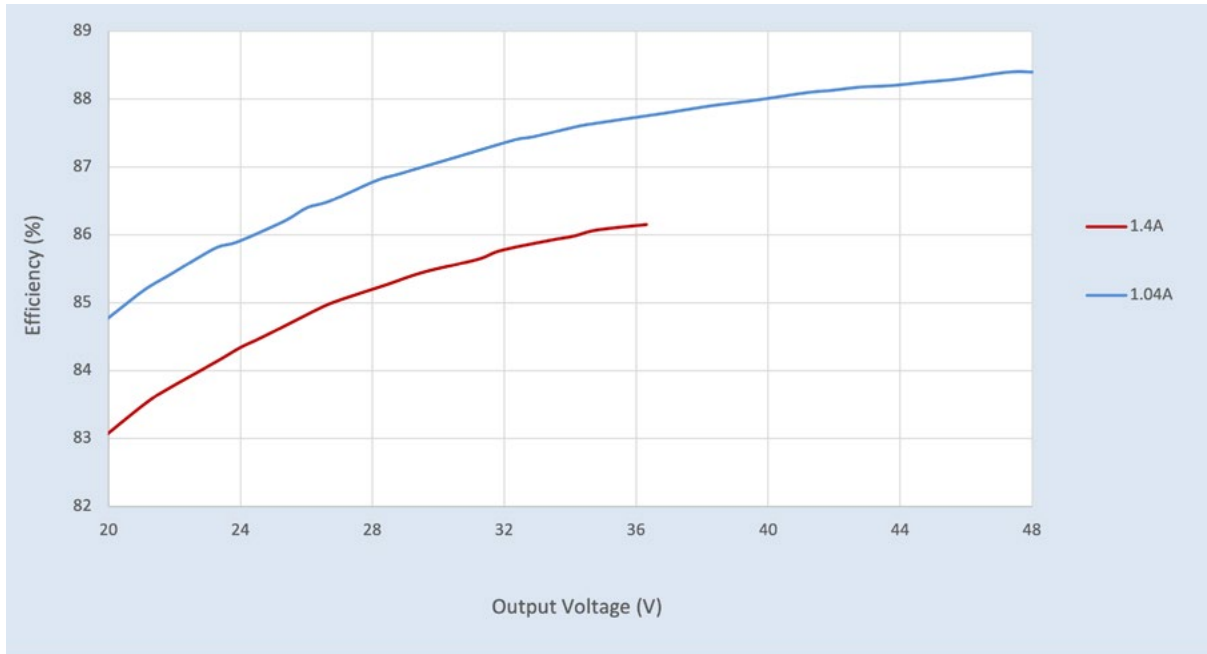

Efficiency Vs. Output Voltage at 277Vac

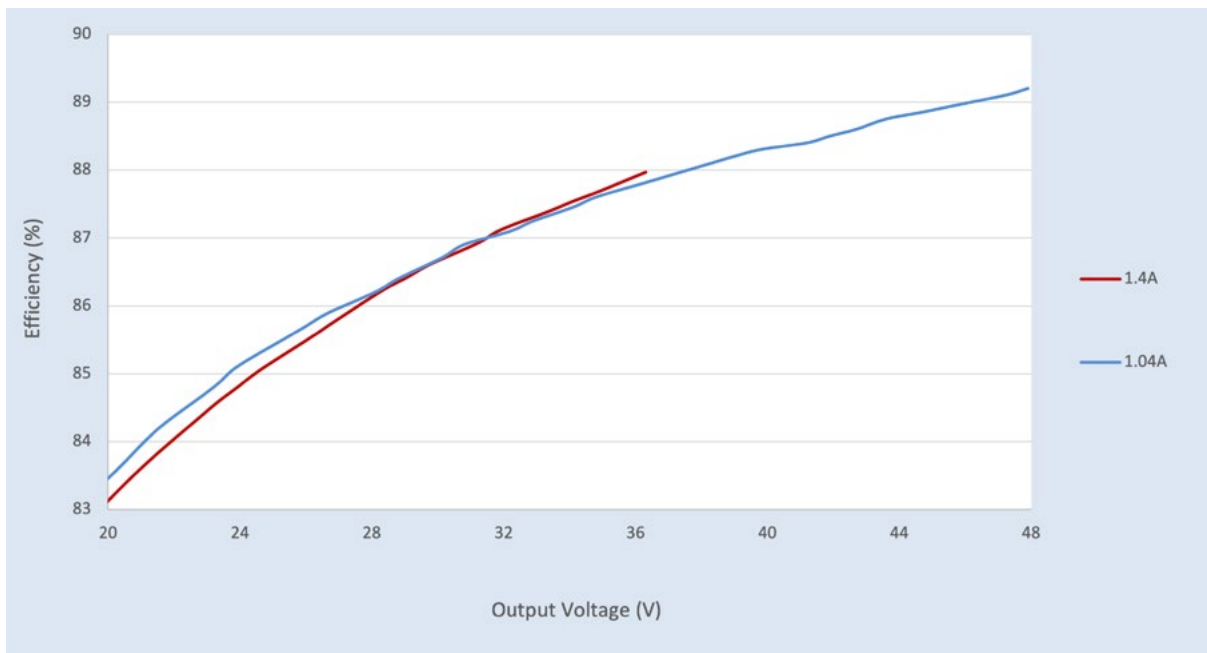

Xitanium XI050C140V048BPT1

50W 0.1-1.4A 48V 0-10V INT (1% dim) with SimpleSet

Performance Characteristics

Based on measurements on a typical sample at 70°C case. The accuracy of the measurements is within the tolerance of the measurement instruments.

Power Factor Vs. Output Power

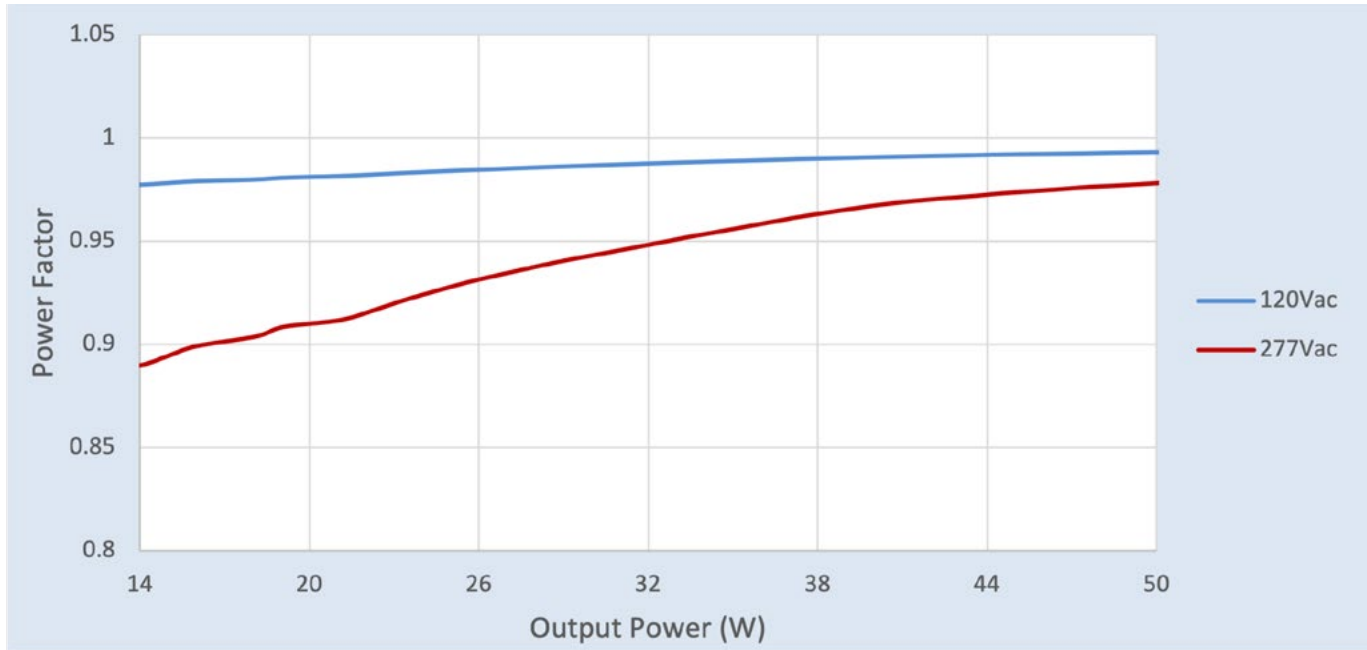

Total Harmonic Distortion (%)

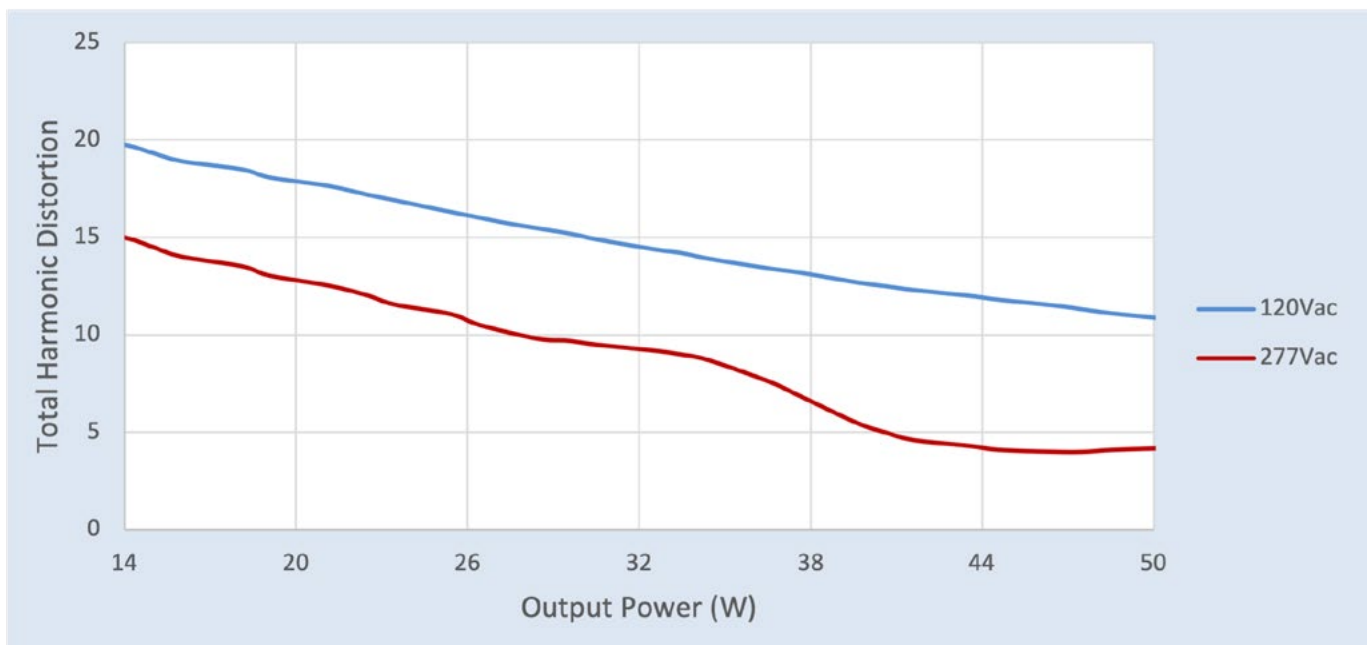

Xitanium XI050C140V048BPT1

50W 0.1-1.4A 48V 0-10V INT (1% dim) with SimpleSet

Inrush Current Info

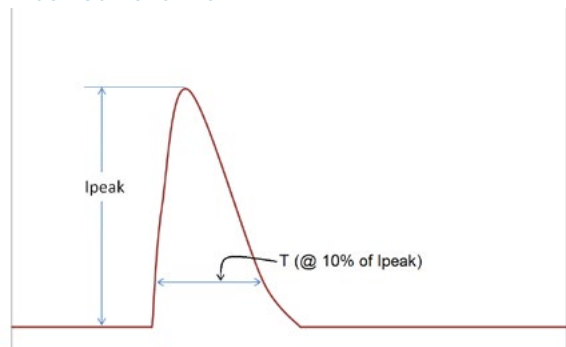

V_{in}	I_{peak}	T (@ 10% of I_{peak})
120 Vrms	6.8A	18.5 μ s
277 Vrms	13.3A	36 μ s

Inrush current is measured at peak of the corresponding line voltage. Source impedance per NEMA 410.

Lightning Surge Info

ANSI Surge Type	Differential Mode (L-N)	Common Mode (L-G, N-G, L&N-G)
100kHz Ring Wave (w/t 30 Ω)	2.5KV	2.5KV

Isolation

Isolation	Input	Output	0-10V	Enclosure
Input	-	2xU+1kV	2xU+1kV	2xU+1kV
Output	2xU+1kV	-	-	500V
0-10V	2xU+1kV	-	-	2xU+1kV
Enclosure	2xU+1kV	500V	2xU+1kV	-

U = Max input voltage

The information presented in this document is not intended as any commercial offer and does not form part of any quotation or contract.



© 2021 Signify Holding. All rights reserved. The information provided herein is subject to change, without notice. Signify does not give any representation or warranty as to the accuracy or completeness of the information included herein and shall not be liable for any action in reliance thereon. The information presented in this document is not intended as any commercial offer and does not form part of any quotation or contract, unless otherwise agreed by Signify.

Signify North America Corporation
200 Franklin Square Drive,
Somerset, NJ 08873
Telephone 855-486-2216

Signify Canada Ltd.
281 Hillmount Road,
Markham, ON, Canada L6C 2S3
Telephone 800-668-9008

All trademarks are owned by Signify Holding or their respective owners.