

BSL23

Installation Instructions

EMERGENCY LED DRIVER

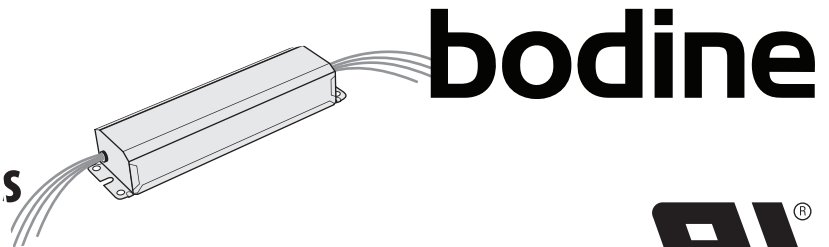

! IMPORTANT SAFEGUARDS !

WHEN USING ELECTRICAL EQUIPMENT, BASIC SAFETY PRECAUTIONS SHOULD ALWAYS BE FOLLOWED, INCLUDING THE FOLLOWING:

READ AND FOLLOW ALL SAFETY INSTRUCTIONS

1. To prevent high voltage from being present on yellow & yellow/black output leads prior to installation, converter connector must be open. Do not join converter connector until installation is complete and AC power is supplied to the emergency driver.
2. This product is for use with an LED lighting load and supplies up to 4.5 W of power at a maximum rated current of 410 mA with a voltage between 3.0 VDC and 20.0 VDC in emergency mode for a minimum of 90 minutes.
3. Make sure all connections are in accordance with the National Electrical Code and any local regulations.
4. To reduce the risk of electric shock, disconnect both normal and emergency power supplies and converter connector of the emergency driver before servicing.
5. This emergency driver is for factory installation only.
6. This product is suitable for use in damp locations where the ambient temperature is 0°C minimum, +50°C maximum. Product is also suitable for installation in sealed and gasketed fixtures. Product is not suitable for heated air outlets and wet or hazardous locations.
7. An unswitched AC power source is required (120 or 277 VAC, 60 Hz).
8. Do not install near gas or electric heaters.
9. Do not attempt to service the battery. A sealed, no-maintenance battery is used that is not field replaceable. Contact the manufacturer for information on service.
10. The use of accessory equipment not recommended by the manufacturer may cause an unsafe condition.
11. Do not use this product for other than intended use.
12. Servicing should be performed by qualified service personnel.

SAVE THESE INSTRUCTIONS

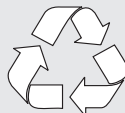

Ni - Cd

**THIS PRODUCT CONTAINS A RECHARGEABLE NICKEL-CADMIUM BATTERY.
THE BATTERY MUST BE RECYCLED OR DISPOSED OF PROPERLY.**

03/06/19

Bodine © 2018 Signify Holding. All rights reserved.

236 Mt. Pleasant Rd. • Collierville, TN USA 38017-2752 • Tech Support 888-263-4638 • Fax 901-853-5009 • www.bodine.com
81000119

INSTALLATION

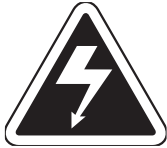

WARNING: TO PREVENT HIGH VOLTAGE FROM BEING PRESENT ON YELLOW & YELLOW/BLACK OUTPUT LEADS PRIOR TO INSTALLATION, CONVERTER CONNECTOR MUST BE OPEN. DO NOT JOIN CONVERTER CONNECTOR UNTIL INSTALLATION IS COMPLETE AND AC POWER IS SUPPLIED TO THE EMERGENCY DRIVER.

NOTE: Make sure the necessary branch circuit wiring is available. An unswitched source of power is required. The emergency driver must be fed from the same branch circuit as the AC driver.

STEP #1 ▶ INSTALLING THE EMERGENCY DRIVER

- > Disconnect AC power from the fixture.
- > Install the emergency driver as shown in Illustration 1.

Note: This is only one example from many possible installation configurations.

- > Refer to the wiring diagrams for complete wiring of the Emergency and AC LED Drivers.

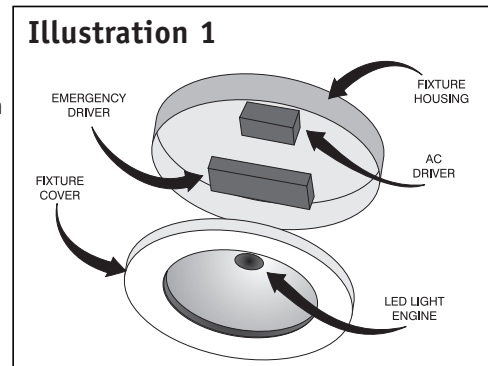

STEP #2 ▶ ILLUMINATED TEST SWITCH (ITS) INSTALLATION

- > Refer to Illustration 1 above and install the ITS through the fixture cover or through the side of the fixture housing.
- > Drill a 3/8" hole and install the ITS as shown.
- > Refer to the wiring diagrams to wire the ITS.

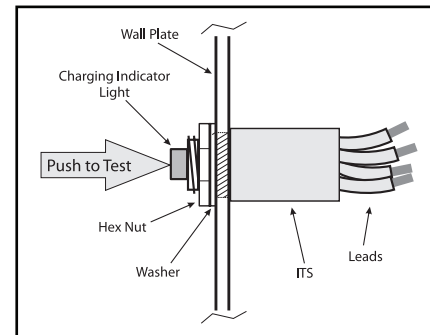

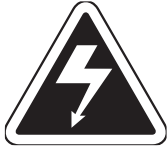

CAUTION: DO NOT CONNECT THE YELLOW AND YELLOW/BLACK LEADS TOGETHER TO PREVENT A SHORT CIRCUIT CONDITION THAT WILL PERMANENTLY DAMAGE THE LED DRIVER.

STEP #3 ► WIRING THE EMERGENCY DRIVER

- > Disconnect the wires between the LED load and the AC driver and connect the blue emergency driver wire to the positive output wire of the AC driver and the yellow emergency driver wire to the positive input to the LED load. Next, connect the negative output wire of the AC driver and the yellow/black emergency driver wire to the negative input to the LED load. See wiring diagrams on the next page.
- > Connect the ITS as shown on the wiring diagram by matching the violet and brown leads and by connecting the black leads to the emergency driver.
- > Follow the corresponding wiring diagram to connect the remaining leads.
- > After installation is complete, supply AC power to the emergency driver and join the converter connector.

STEP #4 ► EMERGENCY DRIVER QUICK CHECK AND LABELING

- > For short-term testing of the emergency function, the battery must be charged for at least one hour. The emergency driver must be charged for at least 24 hours before conducting a long-term test.
- > In a readily visible location, attach the label "CAUTION: This Unit Has More Than One Power Supply Connection Point. To Reduce The Risk Of Electric Shock, Disconnect Both The Branch Circuit-Breakers Or Fuses And Emergency Power Supplies Before Servicing."

OPERATION

When AC power is applied, the ITS is illuminated, indicating the battery is being charged. When power fails, the emergency driver automatically switches to emergency power, operating the LED load at reduced illumination. When AC power is restored, the emergency driver returns to the charging mode. This emergency driver will operate an LED load at a constant current of 200 mA with a voltage between 6.5 VDC and 15.5 VDC and up to 3.1 W of output power for a minimum of 90 minutes.

MAINTENANCE

Although no routine maintenance is required to keep the emergency driver functional, it should be checked periodically to ensure that it is working. The following schedule is recommended:

1. Visually inspect the ITS monthly. It should be illuminated.
2. Test the emergency operation of the fixture at 30-day intervals for a minimum of 30 seconds. The LED load should operate at reduced illumination.
3. Conduct a 90-minute discharge test once a year. The LED load should operate at reduced illumination for a minimum of 90 minutes.

! REFER ANY SERVICING INDICATED BY THESE CHECKS TO QUALIFIED PERSONNEL !

EMERGENCY DRIVER AND AC DRIVER MUST BE FED FROM THE SAME BRANCH CIRCUIT

TYPICAL SCHEMATICS ONLY. MAY BE USED WITH OTHER DRIVERS. CONSULT THE FACTORY FOR OTHER WIRING DIAGRAMS.



CAUTION: DO NOT CONNECT THE YELLOW AND YELLOW/BLACK LEADS TOGETHER TO PREVENT A SHORT CIRCUIT CONDITION THAT WILL PERMANENTLY DAMAGE THE LED DRIVER.

WIRING DIAGRAM

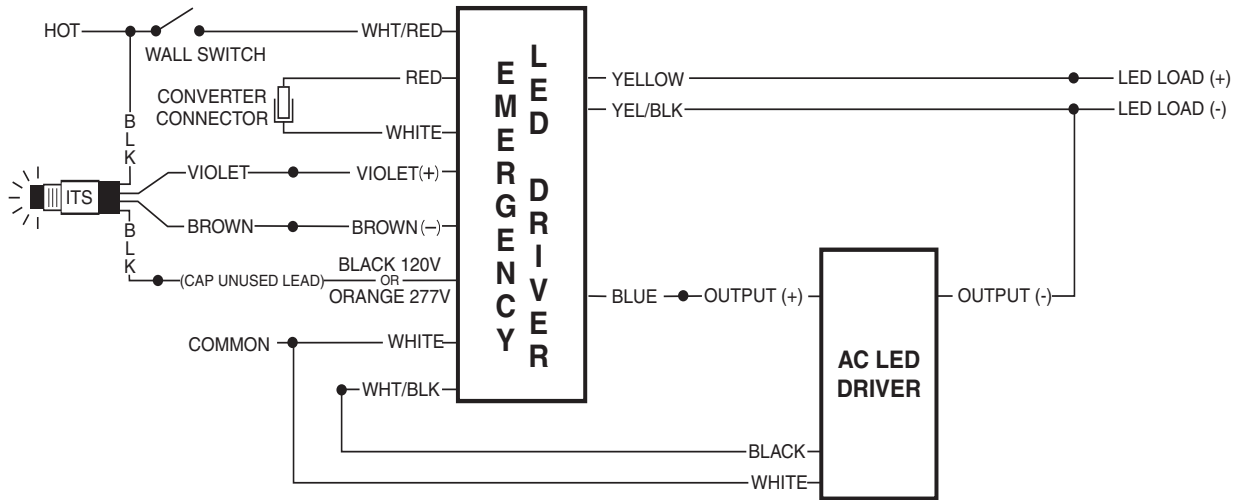

WIRING DIAGRAM FOR FIXTURES WITH THERMAL PROTECTOR

