



Advance CertaDrive indoor LED drivers are designed to meet basic lighting needs. These dimmable drivers are offered with specific voltage-current settings and are, thus, optimized with specifications that are appropriately suited for the application, making LED conversion affordable.

Specifications

Input Voltage (Vac)	Output Power (W)	Output Voltage (V)	Output Current (A)	Efficiency@ Max Load and 70°C Case	Max Case Temp. (°C)	Input Current (A)	Max. Input Power (W)	THD @ Max Load (%)	Power Factor @ Max Load	Surge Protection (Ring Wave, KV)	Envir. Protection Rating	Dimming	Dimming Range	Minimum Output Current (A)	Driver Type
120	23	35-48 Class 2 Output	0.475	85	80°C	0.25	28	<18%	>0.9	2.5	UL damp & dry	0-10V Analog Class 1 and 2 Wiring	10% ~ 100%	0.0475	Constant Current
277				85		0.12									

Enclosure

	In. (mm)
Case Length	8.34 (212)
Case Width (W)	1.37 (33.5)
Case Height (H)	1.10 (27)
Mounting Length (M)	8.90 (226)
Overall Length (L)	9.50 (240)

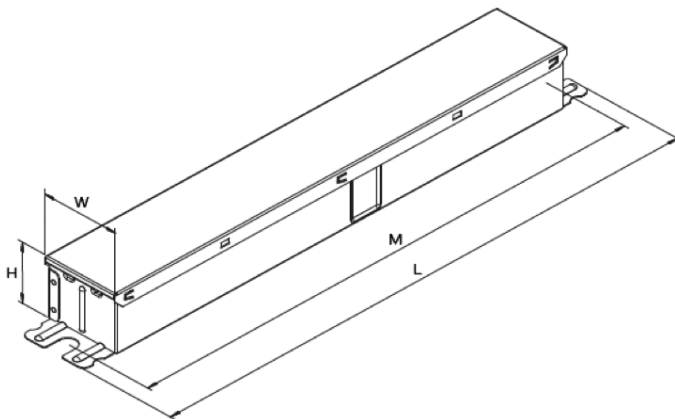

Wiring Diagram

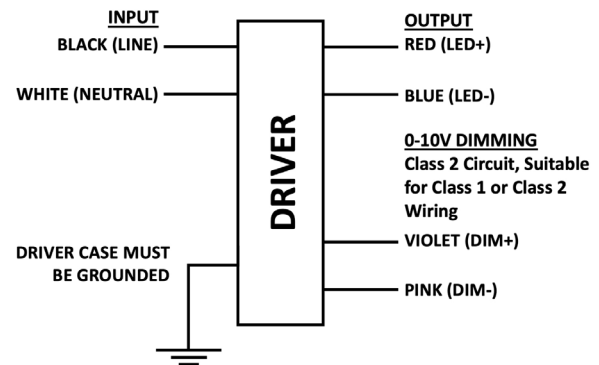

Input and output use lead-wires.

Lead-wires are 18AWG 105C/600V solid copper.

Driver case must be grounded.

Warning

- Install in accordance with national and local electrical codes.
- The field-wiring leads or push-in terminals shall be fully enclosed.



CertaDrive CI023C047V048CNN2

23W 0.475A 48V 0-10V 120-277V

Features

- 50,000+ hour lifetime¹
- Excellent thermal performance
- High power factor & low THD²

Benefits

- Enables long life luminaire designs
- Allows operability in indoor (low-bay) ambient conditions
- Suitable for commercial indoor applications

Application

- Indoor linear troffers, pendants
- Office areas
- Retail centers
- Educational facilities

Electrical Specifications

All the specifications are typical and at 25°C Tcase unless specified otherwise.

Product Data

Order Information	
Full Product Code	CI023C047V048CNN2M (Mid-Pack, 30pcs/Box) 12NC:929001742913
Line Frequency	50/60Hz
Min. Mains Voltage Operational	108 Vac
Max. Mains Voltage Operational	305 Vac
Output Information	
Maximum Open Circuit Voltage	60Vdc, Class 2 output
Output Current Ripple (ripple = peak to average / average)	30% max @ max lout
Output Current Tolerance (at maximum output current)	<8% ²
Protections	Short Circuit, Open Circuit Protection for LED + and LED -
Features	
0-10V Dimming	See dim curve for detail.
Environment & Approbation	
Operating Ambient Temp. Range	-20°C to +50°C
Max Case Temperature (Tcase) ³	80°C, Tcase Life: 65°C
Agency Approbations	UL 8750, UL 1310, cUL, Class P (UL, cUL)
Electromagnetic Compliance	FCC Title 47 Part 15 Class A
Audible Noise	<24dB Class A
Weight	0.46Lbs / 0.21kgs

1. Advance CertaDrive LED drivers are manufactured to engineering standards correlating to a designed and average life expectancy of 50,000 hours of operation at maximum rated case temperature. Minimum 90% survivals based on MTBF modeling.
2. Note: power factor (PF) and total harmonic distortion (THD) may deviate under adverse mains voltage conditions outside nominal operation. Output current (I_{out}) variation includes effects of line and load regulation, temperature variation and component tolerances.
3. For Tc point location, please refer to the Advance CertaDrive design-in guide.

CertaDrive CI023C047V048CNN2

23W 0.475A 48V 0-10V 120-277V

Electrical Specifications

All the specifications are typical and at 25°C Tcase unless specified otherwise.

I_{out} Vs. V_{out}

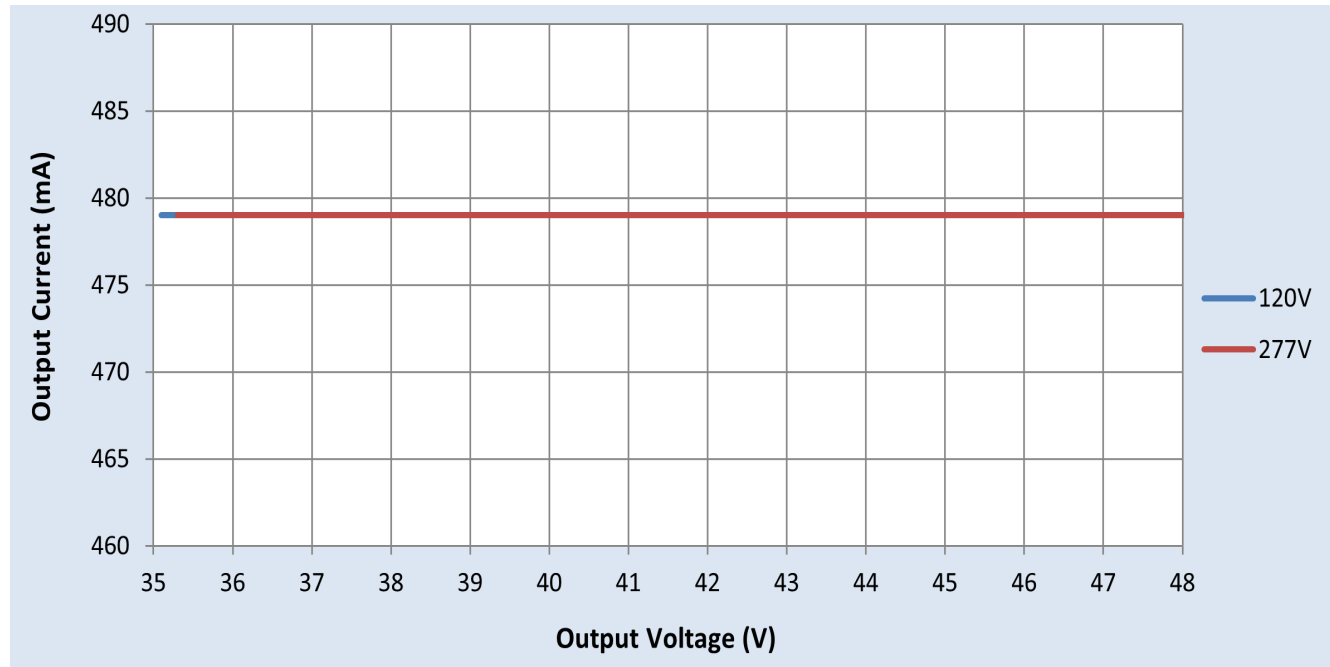

CertaDrive CI023C047V048CNN2

23W 0.475A 48V 0-10V 120-277V

Electrical Specifications

All the specifications are typical and at 25°C Tcase unless specified otherwise.

0-10V Dimming Curve

Dimming source current from the driver: 150µA (@ 0<Vdim<8V)

Minimum dim level: 10% of Iout

Maximum output voltage on the dimming wires: 12V

Approved Dimmer List

Manufacturer	Manufacturer Part Number
Lutron	Visit www.lutron.com
Leviton	IllumaTech IP7 series
Advance	Sunrise - SR1200ZTUNV

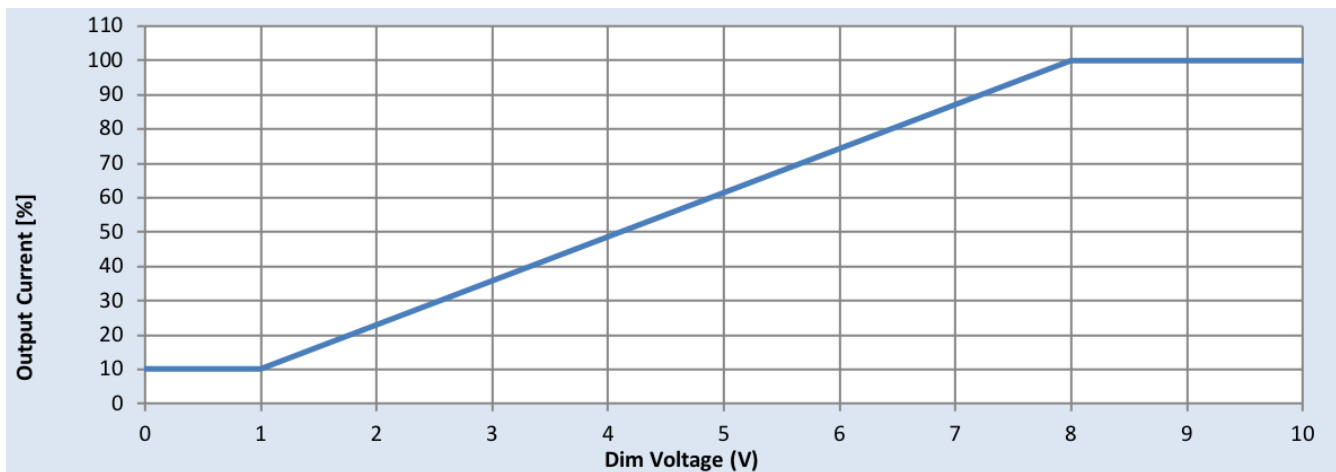

CertaDrive CI023C047V048CNN2

23W 0.475A 48V 0-10V 120-277V

Electrical Specifications

All the specifications are typical and at 25°C Tcase unless specified otherwise.

Output Current Vs. Driver Case Temperature

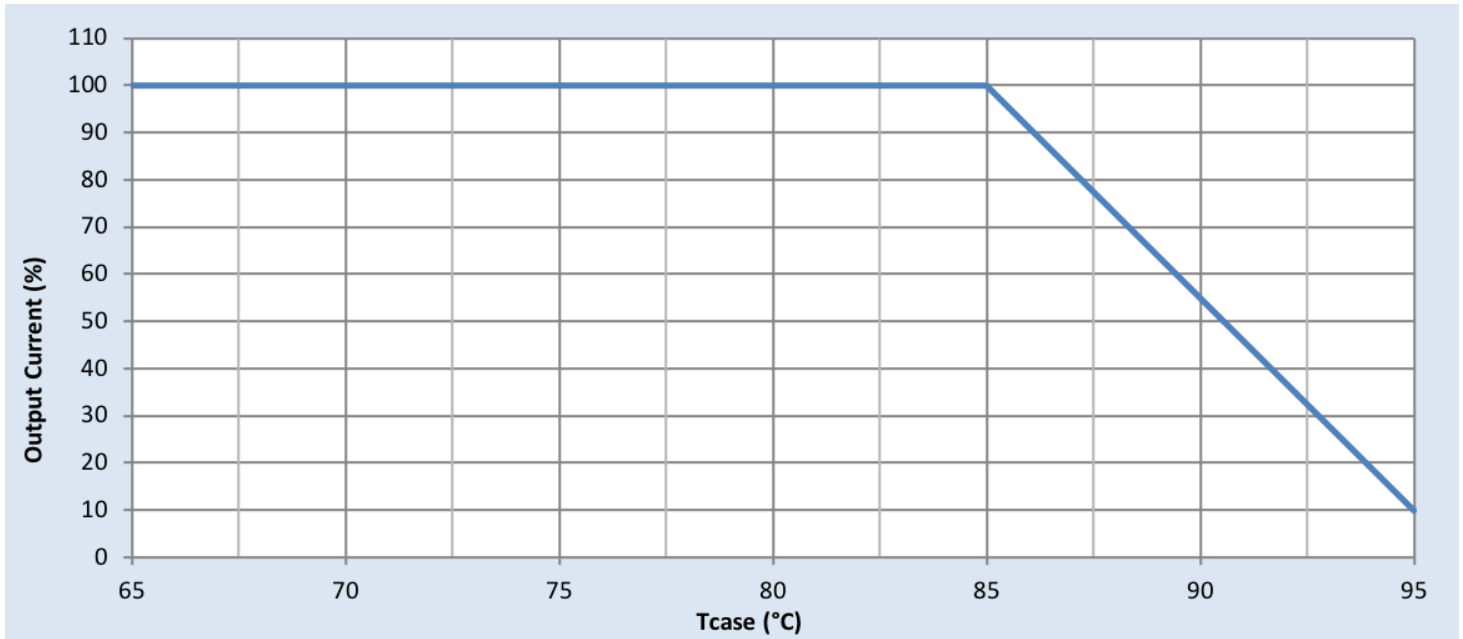

Note: There is $\pm 5^\circ\text{C}$ tolerance on the driver case temperature.

Driver Lifetime Vs. Driver Case Temperature

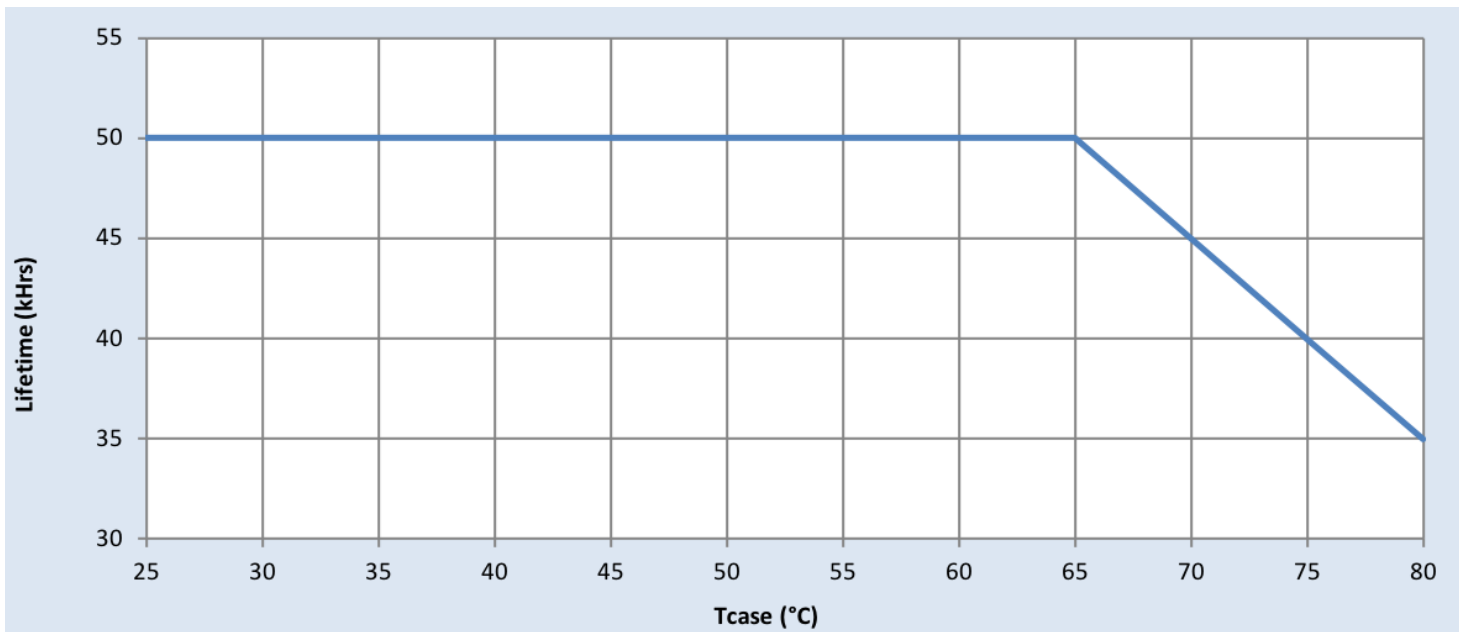

CertaDrive CI023C047V048CNN2

23W 0.475A 48V 0-10V 120-277V

Performance Characteristics

Based on measurements on a typical sample at 70°C case. The accuracy of the measurements is within the tolerance of the measurement instruments.

Efficiency Vs. Output Voltage

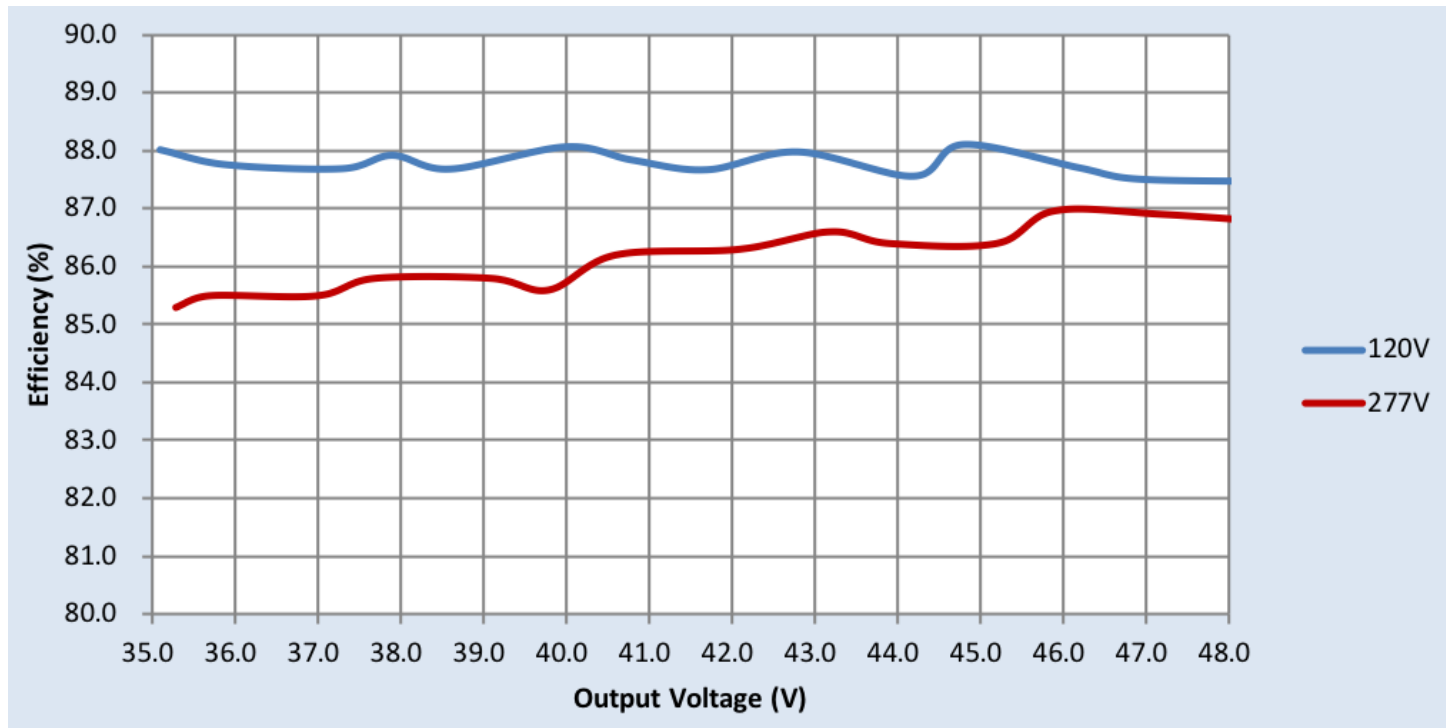

CertaDrive CI023C047V048CNN2

23W 0.475A 48V 0-10V 120-277V

Performance Characteristics

Based on measurements on a typical sample at 70°C case. The accuracy of the measurements is within the tolerance of the measurement instruments.

Power Factor Vs. Output Power

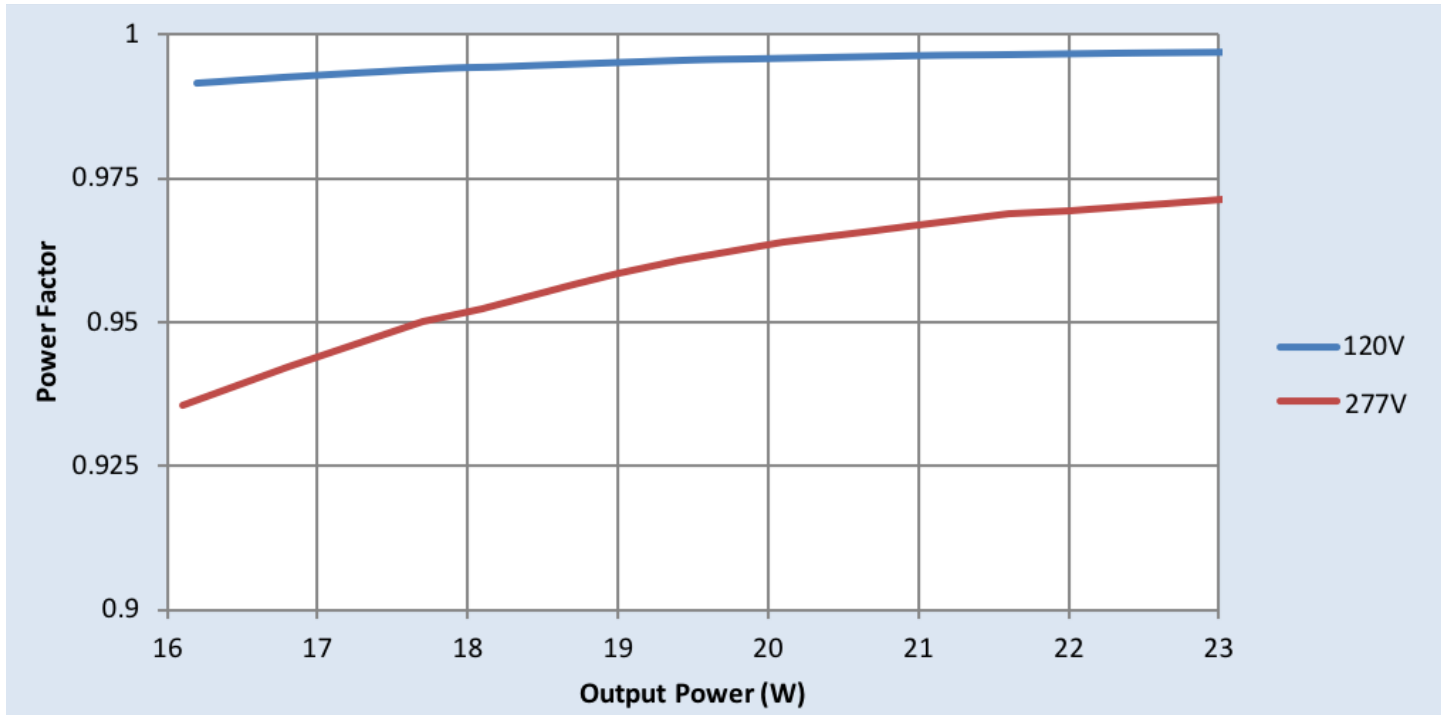

Total Harmonic Distortion (THD) Vs. Output Power

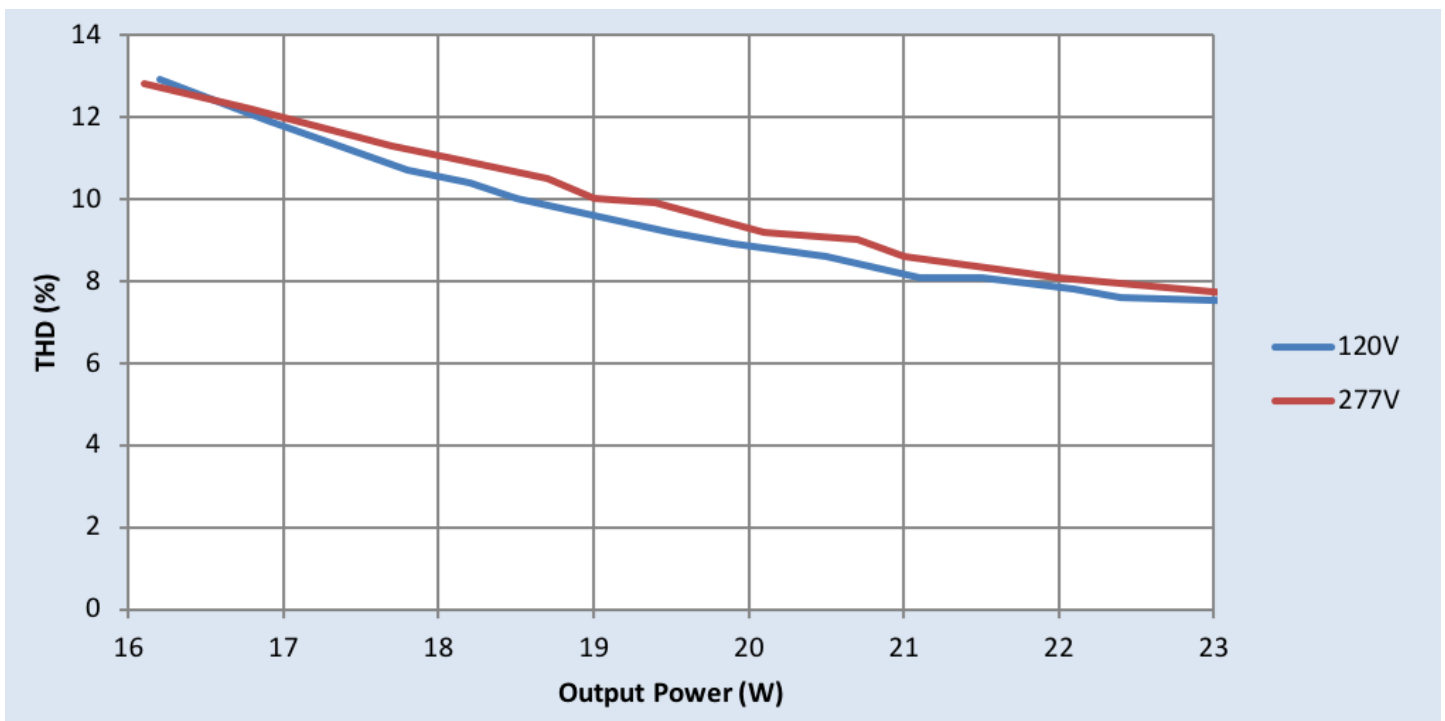

CertaDrive CI023C047V048CNN2

23W 0.475A 48V 0-10V 120-277V

Inrush Current Info

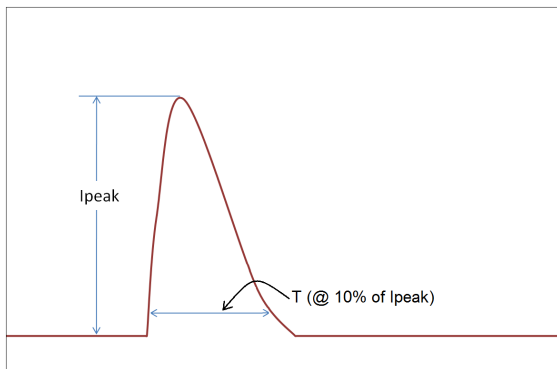

Vin	Ipeak	T (@ 10% of Ipeak)
120 Vrms	9A	42.6µS
277 Vrms	24.35A	50µS

Inrush current is measured at peak of the corresponding line voltage. Source impedance per NEMA 410.

Lightning Surge Info

ANSI Surge Type	Differential Mode (L-N)	Common Mode (L-G, N-G, L&N-G)
100 kHz Ring Wave (w/t 30Ω)	2.5kV	2.5kV

Isolation

Isolation	Input	Output	0-10V	Enclosure
Input	NA	2xU+1kV	2.5kV	2xU+1kV
Output	2xU+1kV	NA	2.5kV	2xU+1kV
0-10V	2.5kV	2.5kV	NA	2xU+1kV

U = Max working voltage



© 2022 Signify Holding. All rights reserved. The information provided herein is subject to change, without notice. Signify does not give any representation or warranty as to the accuracy or completeness of the information included herein and shall not be liable for any action in reliance thereon. The information presented in this document is not intended as any commercial offer and does not form part of any quotation or contract, unless otherwise agreed by Signify.

Signify North America Corporation
400 Crossing Blvd, Suite 600
Bridgewater, NJ 08807
Telephone: 855-486-2216

Signify Canada Ltd.
281 Hillmount Road,
Markham, ON, Canada L6C 2S3
Telephone: 800-668-9008

All trademarks are owned by Signify Holding or their respective owners.